



## DLE WET RATED ADJUSTABLE RECESSED

Client:  
Project:  
Type:  
Quantity:

### CONSTRUCTION

Die-cast aluminum body directional light, with adjustable gimbal 30° tilt and 360° rotation. Available in 2", 3", 4" aperture.

### OPTICS

TIR (Total Internal Reflection) optic provides smooth, uniformed light with 38° beam angle. Gasketed and sealed prevents splash of water or dust objects from entry.

### ELECTRICAL

90+ CRI LEDs.  
120V Input Triac dimming, >0.9 Power Factor 60Hz.  
Operating Temp: -4°F ~ 113°F (-20°C ~ 45°C).  
Field CCT Selectable Function.  
Greater than 70% LED lumen maintenance at 50,000 hours.  
Optional External Emergency Battery 120V Input.

### CONTROL (OPTIONAL)

CONTROL-XFAC AVI-ON Bluetooth Zone Controller Adapter

### MOUNTING

New Construction: No housing required, comes with integral driver in junction box.  
Spring loaded retention arms allow for easy installation into ceilings.

### STANDARD FINISH

Smooth Black finish.  
Smooth White finish.

### CERTIFICATION

Wet location standard.  
Meets Buy America Act requirements.  
All luminaires are built to UL1598 standards and bear appropriate cETLus labels.  
Energy Star Certified.  
California JA8, Title 24 Compliant

### WARRANTY

5 year warranty, see Limited Warranty for additional information.



**DLE WET RATED ADJUSTABLE RECESSED**

**ORDER INFORMATION** **EXAMPLE : DLE 4 WH S**

Fixture	Series	Model	Finish	Input
	<b>DLE</b>		<b>WH</b>	<b>S</b>

Accessories  
Options

**A SERIES**

**DLE** Wet Rated Adjustable Recessed Downlight

**B MODEL**

Code	Trim Type	Power	LM (avg.)	CCT
<b>2</b>	2-inch Trim	5W	426	2700 / 3000 / 3500 / 4000 / 5000K
<b>3</b>	3-inch Trim	8W	707	2700 / 3000 / 3500 / 4000 / 5000K
<b>4</b>	4-inch Trim	12W	992	2700 / 3000 / 3500 / 4000 / 5000K

**C FINISH**

<b>BK</b>	Smooth Black finish
<b>WH</b>	Smooth White finish

**D INPUT**

**S** 120V Input Triac Dimming

**E ACCESSORIES/OPTIONS**

<b>BAA</b>	Assembled in America, compliant with BAA (COTS)
<b>EMB-H18170*</b>	90-Minute Self-Diagnostic Emergency Battery 18W 100-347VAC Input 170VDC Output
<b>CONTROL-XFAC*</b>	AVI-ON Bluetooth Zone Controller Adapter

\*see page 5 for sensor and emb spec

**DLE WET RATED ADJUSTABLE RECESSED**

**DIMENSIONS**

MODEL	W1	L1	L2	H1	H2	CUTOUT
DLE-2	ø2.26"	3.6"	4.53"	1.59"	2.05"	ø2.14"

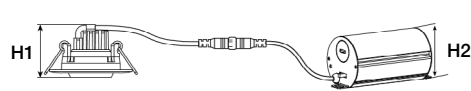
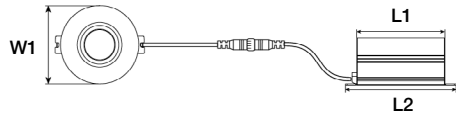

CUTOUT

MODEL	W1	W2	L1	H1	H2	CUTOUT
DLE-3	ø3.35"	1.91"	4.92"	1.81"	1.30"	ø2.84"

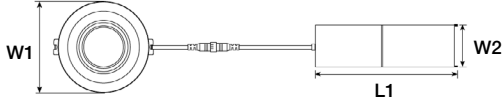

CUTOUT

MODEL	W1	W2	L1	H1	H2	CUTOUT
DLE-4	ø4.92"	2.76"	4.72"	2.24"	1.38"	ø4.25"

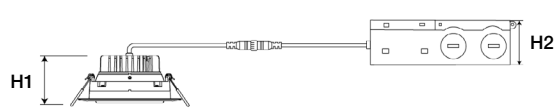
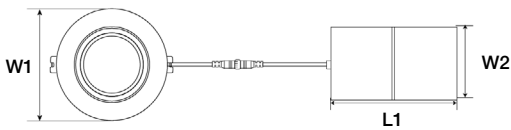

CUTOUT

**DLE WET RATED ADJUSTABLE RECESSED**

**PERFORMANCE DATA**

MODEL	VOLTAGE	WATTAGE	2700K		3000K		3500K		4000K		5000K	
			LUMENS	LPW	LUMENS	LPW	LUMENS	LPW	LUMENS	LPW	LUMENS	LPW
DLE-2	120V	5W	396	79	401	80	415	83	426	85	408	81
DLE-3	120V	8W	573	72	608	76	661	82	707	88	654	81
DLE-4	120V	12W	861	72	901	75	931	77	992	83	978	81

**DLE WET RATED ADJUSTABLE RECESSED**

**EMB SPEC**

Model	Battery Capacity	Input	Output	Output Power	Operating Temp	Installation
EMB-H18170	90mins	100-347VAC	170VDC	18W	0°C ~ 50°C 32°F ~ 122°F	Field Install

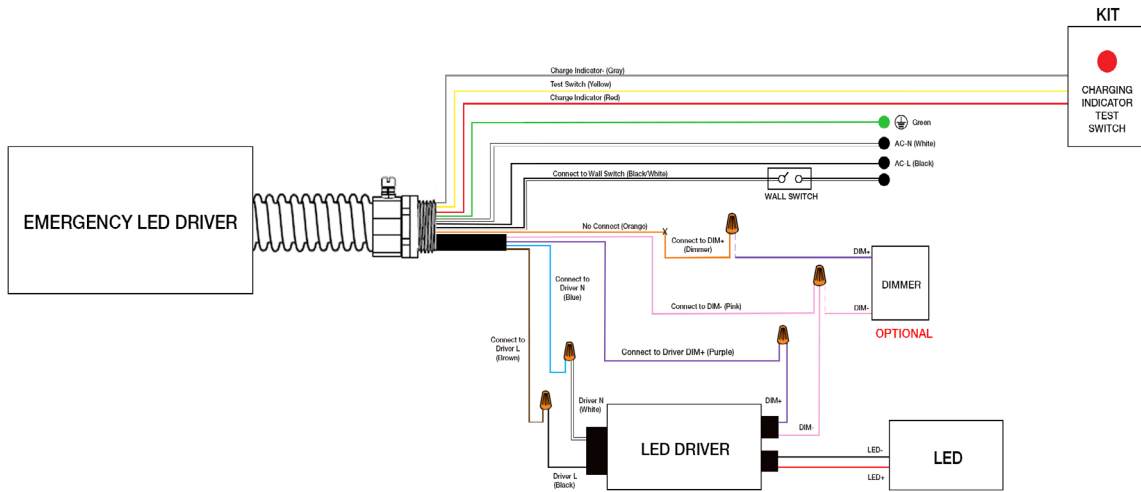

**CONTROL SPEC**

Model	Type	Mounting	Coverage	Input	Function	Programmable
CONTROL-XFAC (see page 6 for detail)	Fixture Controller	-	-	100-277VAC	Bluetooth On/Off/Dimming Scheduling	AVI-ON Bluetooth Mobile App



CONTROL-XFAC

**DLE WET RATED ADJUSTABLE RECESSED**

**CONTROL-XFAC SPEC**

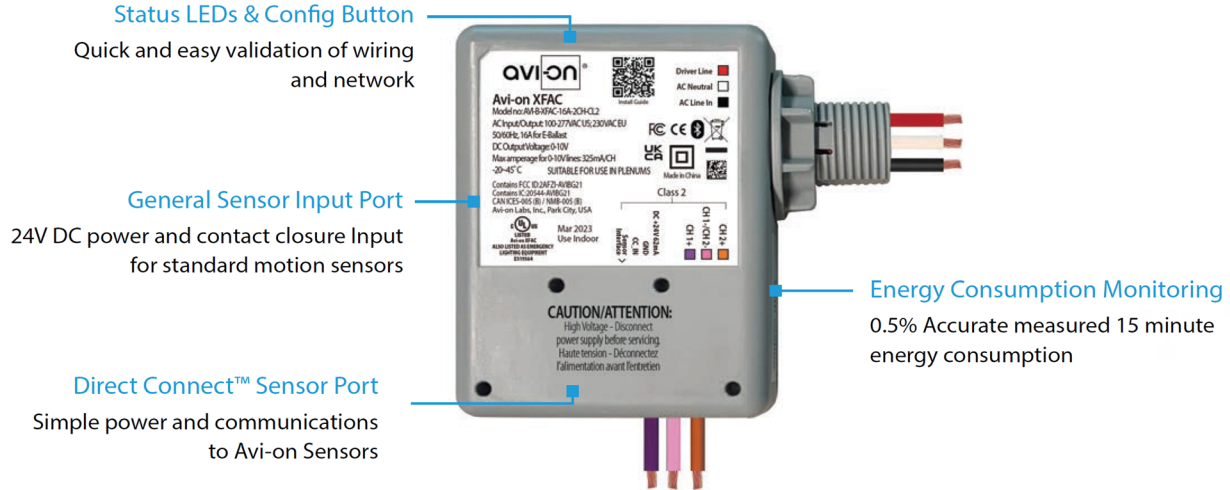

**SPECIFICATIONS**

**INPUT VOLTAGE:** 100-277VAC  
**CURRENT:** MIN: 20 / 14mA  
 MAX: 81 / 46mA

**0-10V DIMMING:** 100-277VAC  
**SIZE:** 3.58" x 3.58" x 1.57"  
 (91mm x 91mm x 40mm)  
**STORAGE TEMP:** -40°F to + 185°F (-40°C to + 85°C)  
**OPERATING TEMP:** -4°F to + 113°F (-20°C to + 45°C)

**RADIO FREQUENCY:** 50/60Hz  
**RELAY CURRENT:** 16A  
**PROTECTION/IMMUNITY:** LEVEL 4  
 Contact Discharge: ± 8kV  
 Air Discharge: ±12kV  
**AMPERAGE FOR 0-10V LINES:** 325mA / CH  
**WARRANTY:** 5 years  
**REGULATORY:** FCC: 2AFZI-AVIBG21  
 IC: 20544-AVBG21  
 BQB: D059595, DID: 185220  
 UL 924, 2043

**WIRING DIAGRAM**

