



TLKIT SERIES TUBE LIGHT LINEAR STRIP KIT

Client:
Project:
Type:
Quantity:

CONSTRUCTION

2-Foot and 4-Foot compact design, machine stamped aluminum housing with semi-gloss White finish.

OPTICS

End-to-end frosted polycarbonate (PC) lens.
Seamless end-to-end connection with optional flexible jumper connector for corner and curved application.

ELECTRICAL

Delivered 160lm/W efficacy LEDs offer 80+ color rendering index (CRI), L70 >50,000 hours expected life.
Driver operates at 120-277V input, 0-10V dimmable down to 10% w/ AUX 12V output.

MOUNTING

Designed for direct wire or as a portable luminaire with use of power cord.
Bypass socket, tombstones and ballast, simple and reliable retrofit solution for T5, T8 and T12 fixtures.

STANDARD FINISH

Semi-gloss White finish, suitable for damp location.

CERTIFICATION

Damp location label standard.
All luminaires are built to UL1598 standards and bear appropriate cETlus labels.
DLC® Premium (DesignLights Consortium Qualified).

WARRANTY

5 year warranty, see Limited Warranty for additional information.

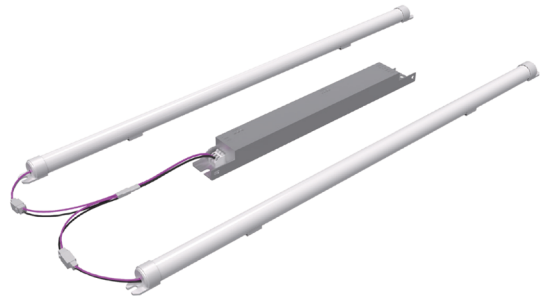

TLKIT SERIES TUBE LIGHT LINEAR STRIP KIT

ORDER INFORMATION **EXAMPLE: TLKIT 2L2 40 SM UD25**

Fixture	Series	Size	CCT	Mounting	Input
	TLKIT		40	SM	

Accessories
Options

A SERIES

TLKIT Tube Light Linear Strip Kit

B SIZE

CODE	SIZE	POWER	LUMEN
2L2	2x2	Field Selectable 10 / 15 / 20 / 25W	1,600 / 2,400 / 3,200 / 4,000lm
2L4	2x4	Field Selectable 25 / 30 / 35 / 45W	4,000 / 4,800 / 5,600 / 7,200lm

C CCT

40 4000K

D MOUNTING

SM Snap-on magnetic surface mount clip (pair)

E INPUT

UD25 25W MAX Selectable Output Driver 120-277V Input 0-10V Dimming w/ AUX 12V For 2FT Strip
UD45 45W MAX Selectable Output Driver 120-277V Input 0-10V Dimming w/ AUX 12V For 4FT Strip

F ACCESSORIES/OPTIONS

- BAA** Assembled in America, compliant with BAA (COTS)
- JUMPER-TLKIT-36** 36" Jumper Cable (used between Splitter Lead and Fixture Lead)
- CONTROL-LVFA*** AVI-ON Bluetooth Mesh Control System
- EMB-H08170*** 90-Minute Self-Diagnostic Emergency Battery 8W 100-347VAC Input 170VDC Output
- EMB-H18170*** 90-Minute Self-Diagnostic Emergency Battery 18W 100-347VAC Input 170VDC Output
- SENSOR-ANT-7*** Integral Microwave Bi-Level Motion Sensor
- SENSOR-BLE-7*** Integral Microwave Bluetooth Wireless Bi-Level Motion Sensor (ALS Control Mobile App)
- REMOTE-RC100** Handheld Remote Commissioning Tool for SENSOR-ANT (1 per job)

*see page 5 for sensor and emb spec

TLKIT SERIES TUBE LIGHT LINEAR STRIP KIT

DIMENSIONS

Model	L1	L2
TLKIT-2L2	21.02" (534mm)	11.06" (281mm)
TLKIT-2L4	44.37" (1127mm)	12.40" (315mm)

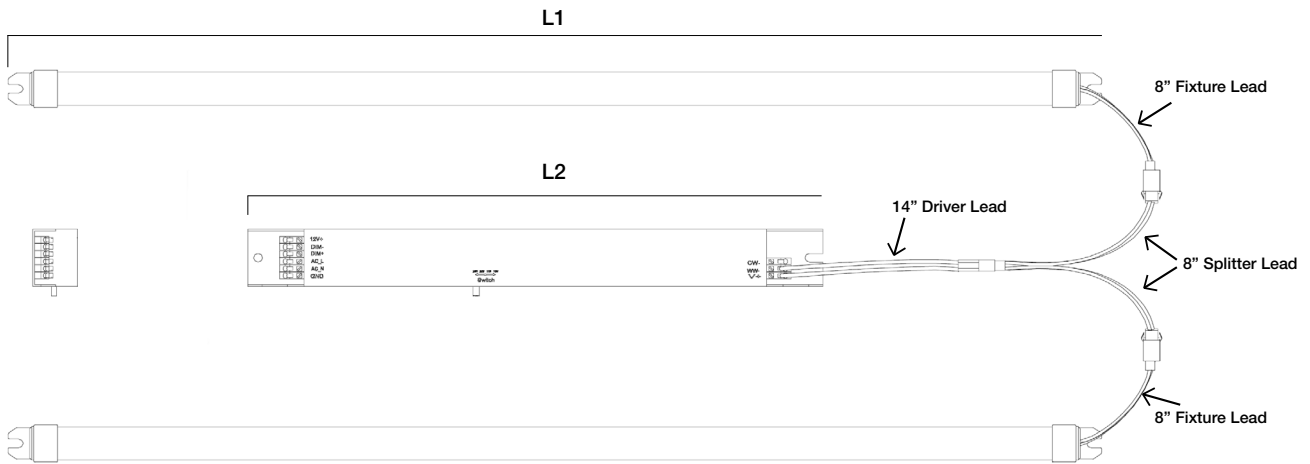

Model	W1	W2	H1	H2
TLKIT-2L2	1.22" (31mm)	0.79" (20mm)	0.87" (22mm)	0.75" (19mm)
TLKIT-2L4	1.22" (31mm)	0.79" (20mm)	0.87" (22mm)	0.75" (19mm)

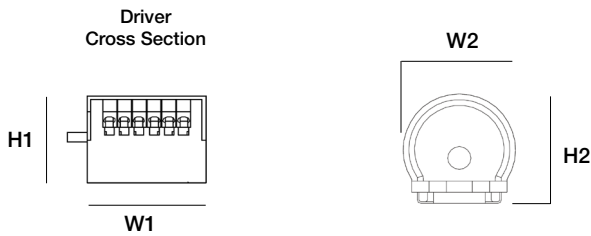

MOUNTING



Snap-on magnetic surface mount clip (pair)

W1: 1.08" (27mm)

W2: 0.79" (20mm)

H: 0.40" (10mm)

TLKIT SERIES TUBE LIGHT LINEAR STRIP KIT

ELECTRICAL DATA

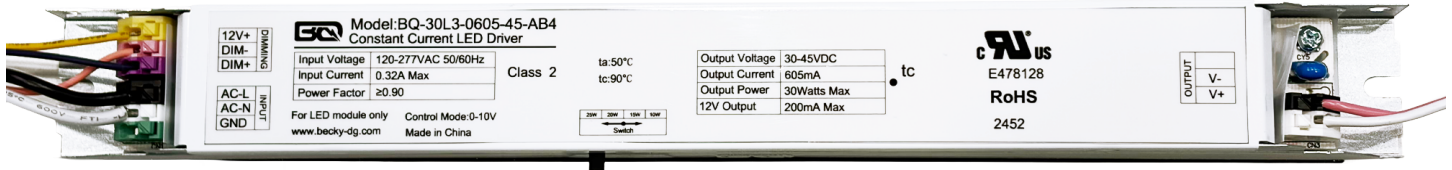

DRIVER	SELECTABLE WATTAGE	INPUT VOLTAGE	DIMMING PROTOCOL	INPUT CURRENT	POWER FACTOR	12V OUTPUT
DRIVER-TL-UD25 SKU: BQ-30L3-0605-45-AB4	10W / 15W / 20W / 25W	120-277VAC	0-10V	0.32A max.	≥0.90	200mA max.
OUTPUT VOLTAGE	OUTPUT CURRENT	OUTPUT POWER	TEMPERATURE RATING (ta)	TEMPERATURE RATING (tc)		
30-45VDC	605mA	18.15W min. 27.23W max.	122°F max. (50°C)	194°F max. (90°C)		

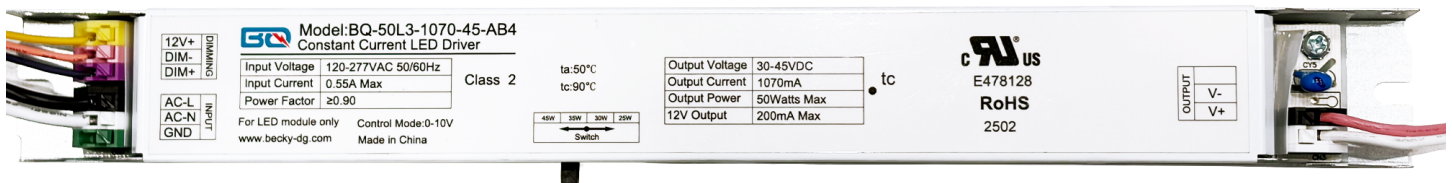

DRIVER	SELECTABLE WATTAGE	INPUT VOLTAGE	DIMMING PROTOCOL	INPUT CURRENT	POWER FACTOR	12V OUTPUT
DRIVER-TL-UD45 SKU: BQ-50L3-1070-45-AB4	25W / 30W / 35W / 45W	120-277VAC	0-10V	0.55A max.	≥0.90	200mA max.
OUTPUT VOLTAGE	OUTPUT CURRENT	OUTPUT POWER	TEMPERATURE RATING (ta)	TEMPERATURE RATING (tc)		
30-45VDC	1070mA	32.1W min. 48.15W max.	122°F max. (50°C)	194°F max. (90°C)		

DLC CODE

Part Number	DLC Product ID	DLC Class
TLKIT-2L2-40-SMUD25-[MO, Blank]	S-GZ4GZW	Premium
TLKIT-2L4-40-SMUD45-[MO, Blank]	S-8K52J0	Premium

TLKIT SERIES TUBE LIGHT LINEAR STRIP KIT

SENSOR SPEC

Model	Type	Mounting	Coverage	Input	Function	Programmable
SENSOR-BLE-7 (see page 7 for detail)	Microwave	up to 13FT	17FT radius	12V DC	Bluetooth Mesh On/Off/Dimming Motion Daylight Sensing	ALS Control Bluetooth Mobile App
SENSOR-ANT-7	Microwave	up to 12FT	17FT radius	10V DC	On/Off/Dimming Motion Daylight Sensing	REMOTE-RC100
CONTROL-LVFA (see page 6 for detail)	-	-	-	12V DC	Bluetooth Mesh On/Off/Dimming Scheduling	AVI-ON Bluetooth Mobile App



EMB SPEC

Model	Battery Capacity	Input	Output	Output Power	Operating Temp	Installation
EMB-H08170	90mins	100-347VAC	170VDC	8W	0°C ~ 50°C 32°F ~ 122°F	Factory or Field Install
EMB-H18170	90mins	100-347VAC	170VDC	18W	0°C ~ 50°C 32°F ~ 122°F	Factory or Field Install

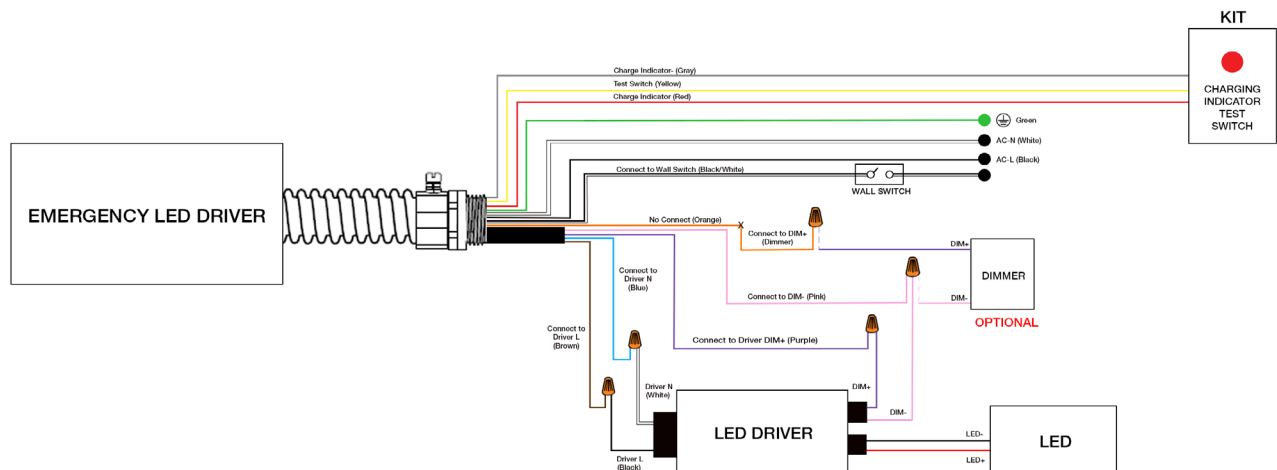

TLKIT SERIES TUBE LIGHT LINEAR STRIP KIT

CONTROL-AVI-LVFA SPEC

Status LEDs & Config Button

Quick and easy validation of wiring and network

Direct Connect™ Sensor Port

Simple and cost-effective addition to Avi-on sensors

Terminal Blocks & Mounting Tabs

Faster, easier and lower cost installation eliminating connectors

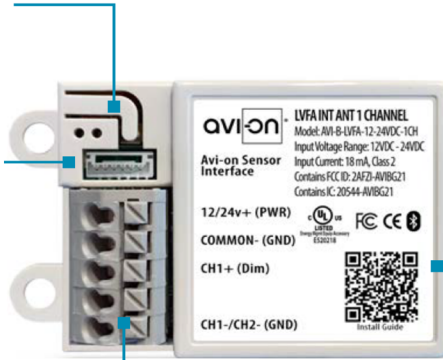

Internal Antenna

Improved performance and eliminates risk of accidentally cutting a hanging wire

SPECIFICATIONS

INPUT VOLTAGE: 12-24VDC
CURRENT: 15mA without a Sensor
 19mA with a DC PIR Sensor
 48mA with a DC Microwave Sensor
0-10V DIMMING: 12-24VDC
SIZE: 2.30in x 1.43in x 0.75in
 (58.2mm x 36.4mm x 19mm)
MOUNTING: Removable mounting tabs
WEIGHT: 0.45 oz (16g)
OPERATING TEMP: -22°F to +158°F (-30°C to + 70°C)

RADIO FREQUENCY: 2.4GHz
WIRELESS STANDARD: BLE 4.2 with Mesh
POINT TO POINT RANGE*: 80ft with obstructions
 350ft unobstructed
SECURITY: AES 128-bit encryption for device to device communication
 AES 256-bit encryption for device to cloud communication
WARRANTY: 5 years; 10 years optional
REGULATORY: FCC: 2AFZI-AV1010 B
 IC: 20544-AV1010 B
 BQB: D031801, DID: 86303
 UL 916, 2043 (Plenum Rated)

*When communicating through the mesh, range is essentially unlimited (5000ft+)

WIRING DIAGRAM

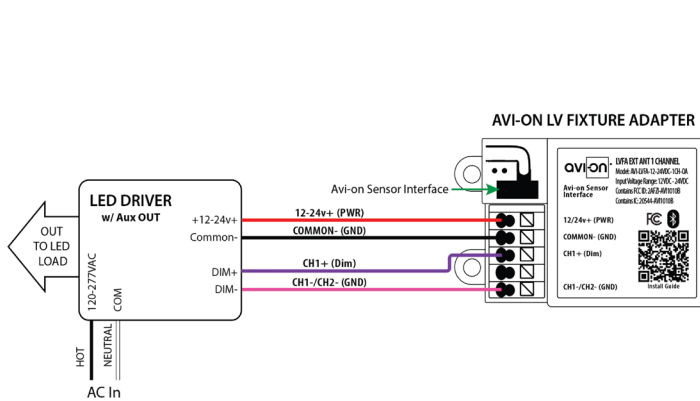

Fixture adapter powered by LED driver auxiliary output

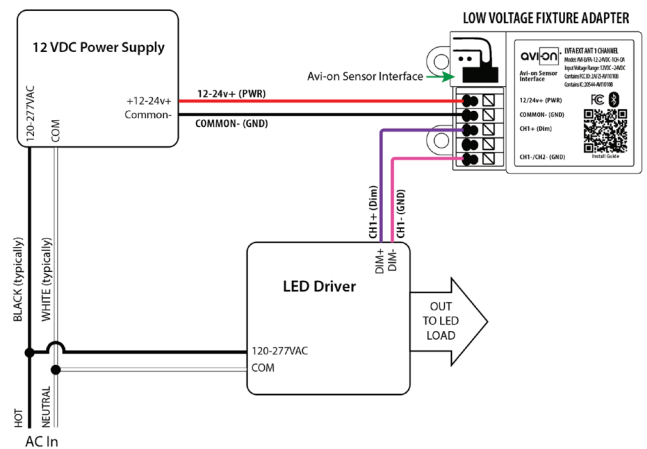

Fixture adapter connected to LED driver and using power supply

FEATURE

- **Installation:** Factory Install - Integral to Fixture
- **Commissioning:** Wirelessly through ALS Control Mobile App (iOS / Android)
- **Certification:** DLC 5.1 Networked Lighting Control System
- **Control:** Hold time, High-Low setting, continuous Bi-level dimming, Code-compliant manual-on or auto-off capability
- **Sensor:** Motion (Occupancy/Vacancy/Manual)
- **Room and Zone Control:** Zoning and Grouping control, Scheduling



SPECIFICATIONS

SENSOR TYPE: Microwave
WIRELESS STANDARDS: Bluetooth SIG Mesh
INPUT VOLTAGE: 10-14VDC, >50mA
CONTROL OUTPUT: 0-10V
OPERATING TEMP: -40°F ~ +158°F (-40°C ~ +70°C)

COMMISSIONING RANGE: 50FT
BLUETOOTH RANGE: Integral antenna up to 164FT
DETECTION ANGLE: 360°
MOUNTING HEIGHT: Up to 13FT
WARRANTY: 5 years
IP RATING: IP20

DIMENSIONS

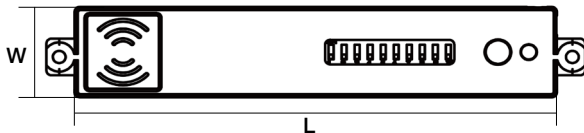

L	W
3.70" (94mm)	0.73" (18.5mm)

COVERAGE PATTERNS

